

EASY TRACK V2 DUO STEEL MOUNTING SYSTEM

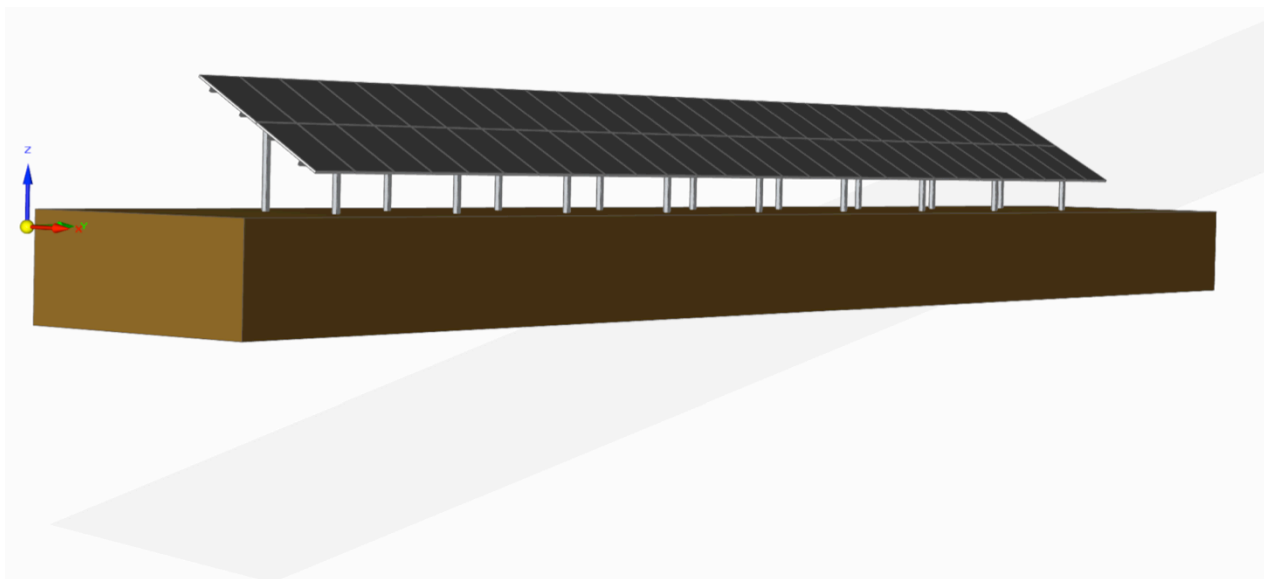

Sample view with PV Panels
for two PV Panels (2x28) upright
above one another



Sample view construction only
for two PV Panels (2x28) upright
above one another

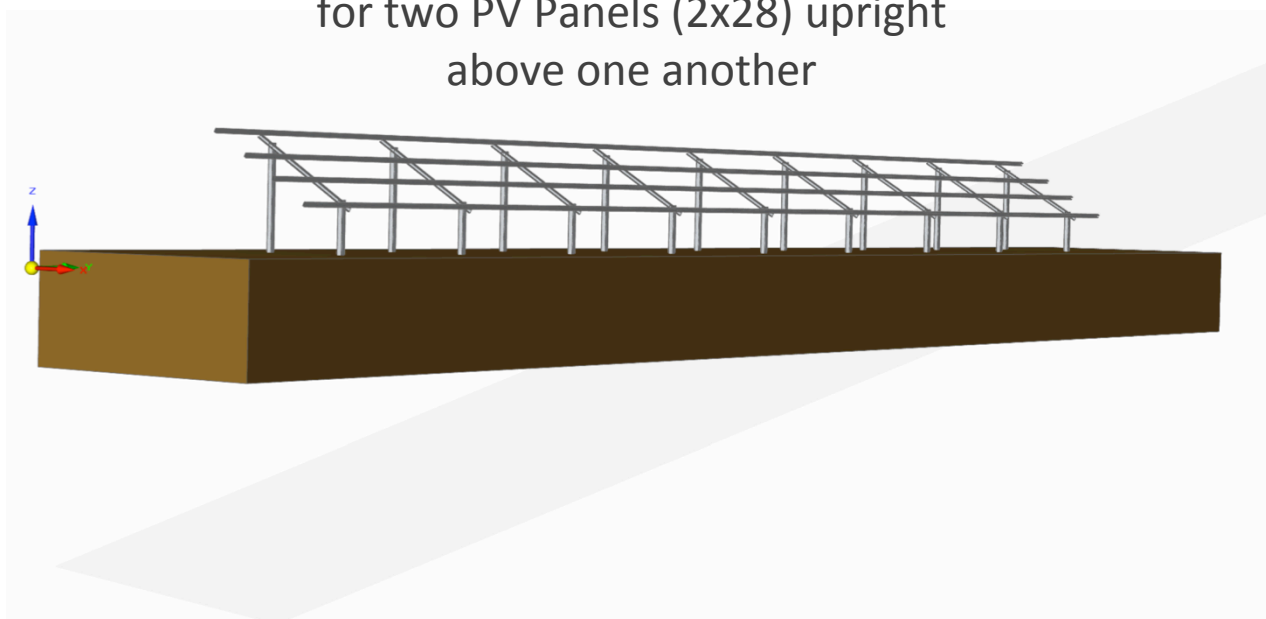

MANUFACTURER CERTIFIED RAL

HiProm Project GmbH
Am Weiher 1
D93194 Walderbach

Tel. +49 (0) 9464.9110093
Fax. +49 (0) 9464.9110094

Email. info@hi-prom.de
Web. www.hi-prom.de



<http://www.facebook.com/hiprom>



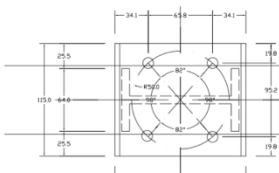

EASY TRACK V2 DUO STEEL MOUNTING SYSTEM



Sample side view
for two PV Panels upright
above one another

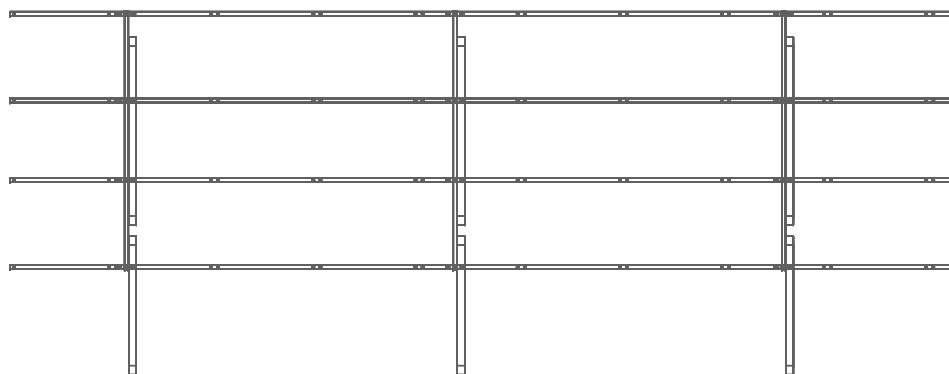

Top view without
PV modules

Plan view of the top
with PV modules

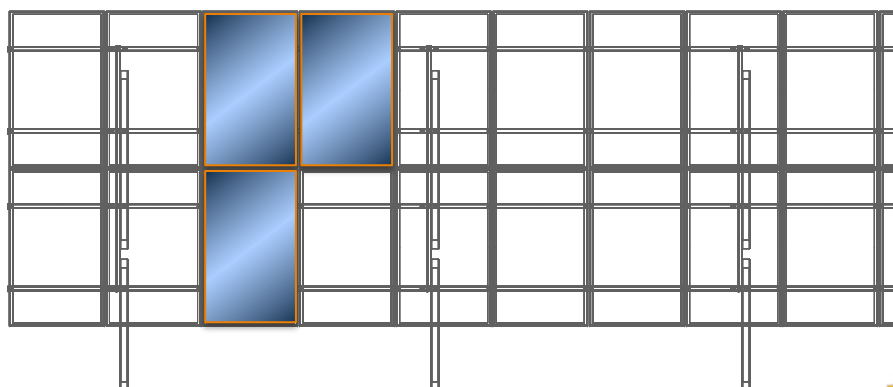

MANUFACTURER CERTIFIED RAL

HiProm Project GmbH
Am Weiher 1
D93194 Walderbach

Tel. +49 (0) 9464.9110093
Fax. +49 (0) 9464.9110094

Email. info@hi-prom.de
Web. www.hi-prom.de



<http://www.facebook.com/hiprom>



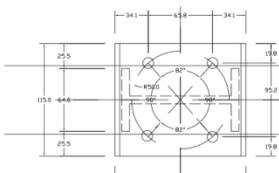

EASY TRACK V2 DUO STEEL MOUNTING SYSTEM



Installation PV modul at the original mounting points

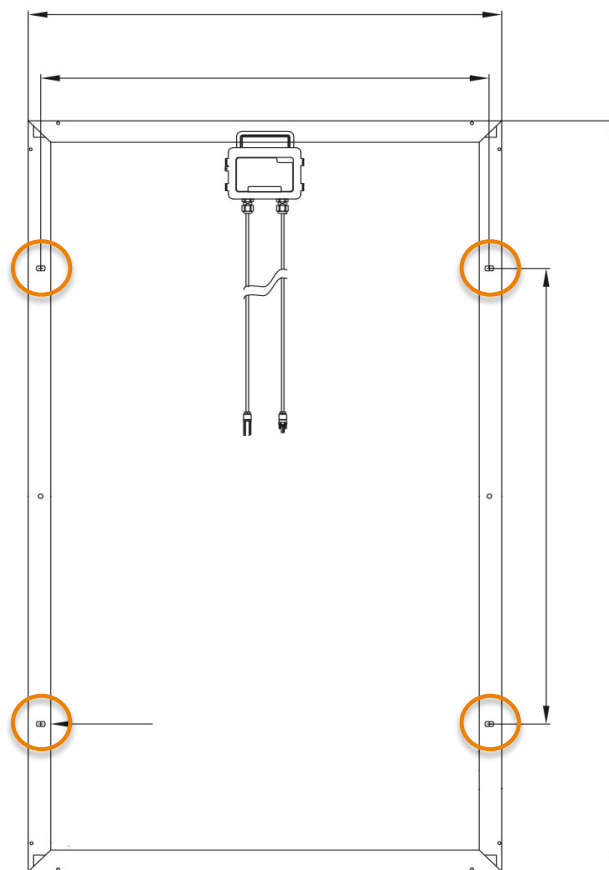

Mounting from bottom

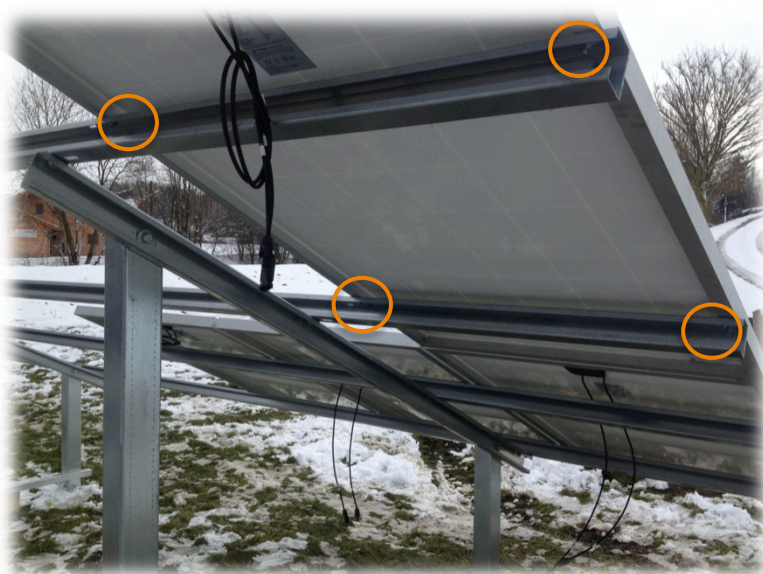

MANUFACTURER CERTIFIED RAL

HiProm Project GmbH
Am Weiher 1
D93194 Walderbach

Tel. +49 (0) 9464.9110093
Fax. +49 (0) 9464.9110094

Email. info@hi-prom.de
Web. www.hi-prom.de



<http://www.facebook.com/hiprom>



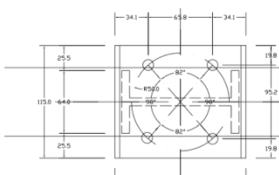

EASY TRACK 1/2 DLIO STEEL MOUNTING SYSTEM



Technical data

EASY TRACK 1/2 DLIO STEEL	
Location of installation	the soil
Wind resistance	according to the conditions of the region and the individualized structural analysis
Snow load	according to the conditions of the region and the individualized structural analysis
Placement of the modules	in a row with the possibility of standing or lying
Arrangement of the modules/slope of incline/ Distance of the lower module edge from the ground	flexible
Spacing of the supports	according to the structural requirements
Norms	DIN 1055 - the influence on the carrier system EUROCODE 9 part 1.1. - the lay-out and construction of the aluminum carrier systems
Material	the construction profile and fitting materials are made from galvanized construction steel and stainless steel.
Color	zinc - plated
Protection against corrosion	all parts are hot-dip galvanized
Warranty	Two-year warranty and five-year guarantee for the product's characteristics



MANUFACTURER CERTIFIED RAL

HiProm Project GmbH
Am Weiher 1
D93194 Walderbach

Tel. +49 (0) 9464.9110093
Fax. +49 (0) 9464.9110094

Email. info@hi-prom.de
Web. www.hi-prom.de



<http://www.facebook.com/hiprom>

